



FOLDING DOOR SYSTEM

SERIES 700 - FOLDING DOORS (FD1)

1503 W. San Pedro St., Gilbert, Arizona 85233

VOICE: 480-892-2600 / FAX : 480-892-0951

L7

DATE:

1/25/13

DRAWINGS\BROPPAGES\L7.DWG

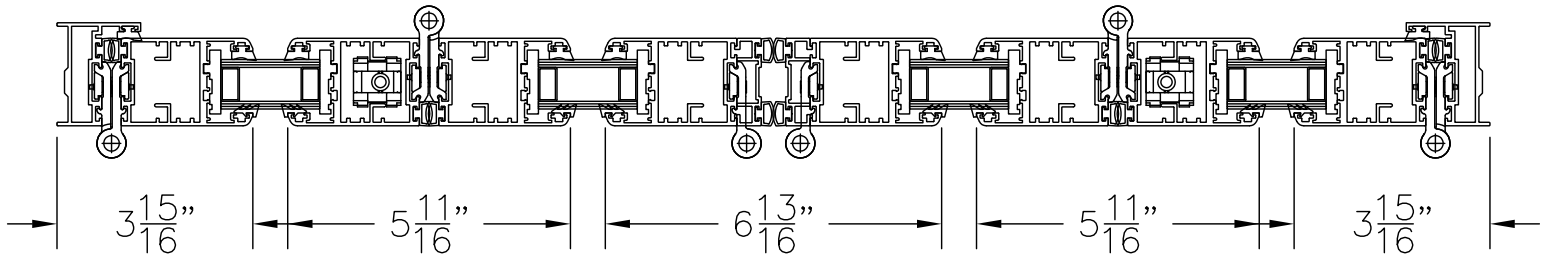

SCALE: 1:4

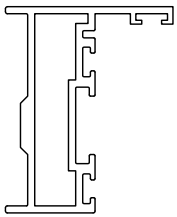

#704

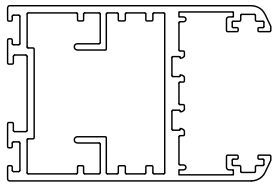

#701

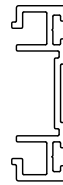

#706

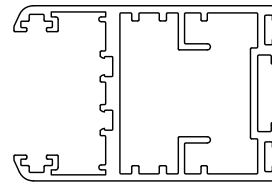

#701

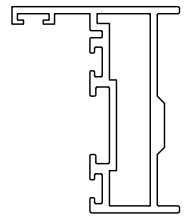

#704

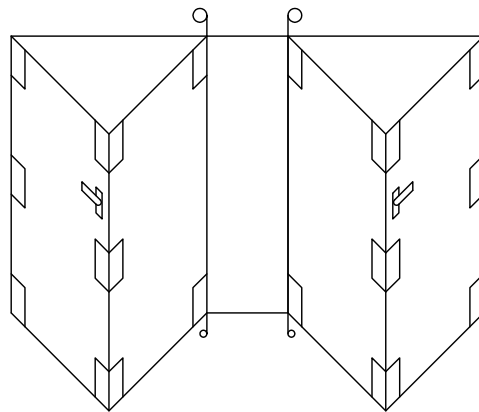

2L2RSO
2L2RSI

HORIZONTAL SECTION THROUGH FOLDING DOOR
DOUBLE GLAZED

SCALE: 1:2