



WINDOW SYSTEM  
SERIES 900 - CASEMENT

1503 W. San Pedro St., Gilbert, Arizona 85233  
VOICE: 480-892-2600 / FAX : 480-892-0951

K5

DATE:  
6/12/13

R:\DRAWINGS\BROGPAGES\K-1\K5.DWG

① FIXED FRAME JAMB &  
CASEMENT PERIMETER  
FRAME JAMB

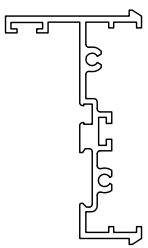
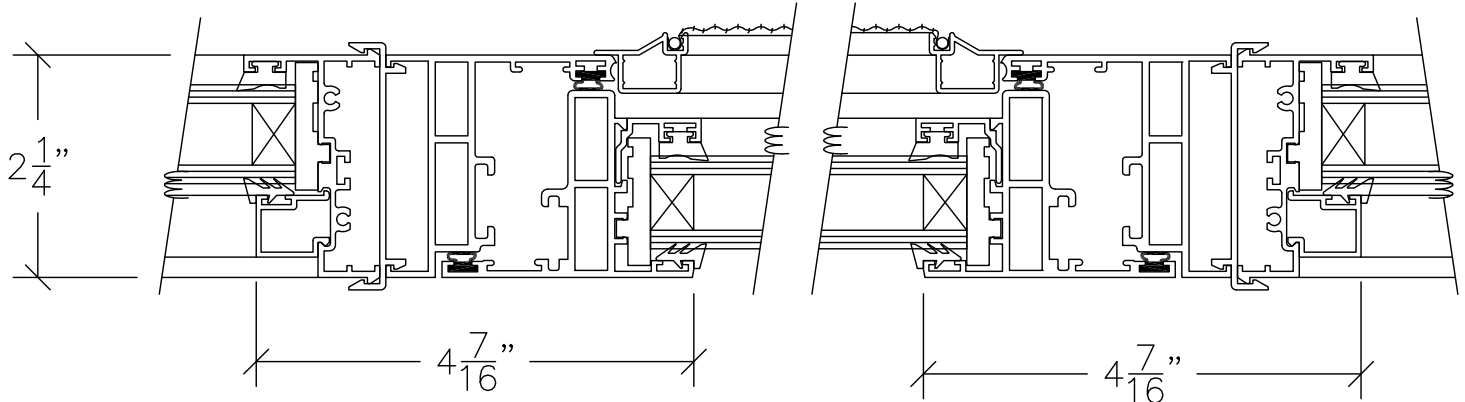

#2293

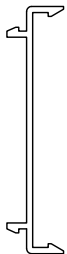

#234

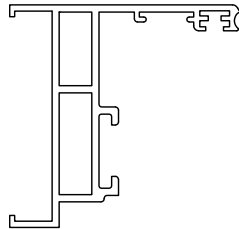

#501

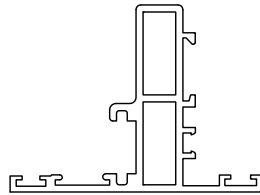

#2502



#441

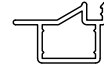

#021



#426

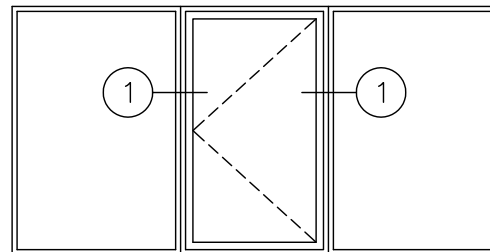

HORIZONTAL SECTION THROUGH CASEMENT / FIXED FRAME MULL  
DOUBLE GLAZED  
SCALE: HALF SIZE