



DOOR SYSTEM – RESIDENTIAL

SERIES 151 – MULTI-SLIDING GLASS DOOR (MSD & MSD4)

1503 W. San Pedro St., Gilbert, Arizona 85233

VOICE: 480-892-2600 / FAX : 480-892-0951

F1

DATE:
12/5/13

DRAWINGS\BROGPAGES\B-F\PL.DWG

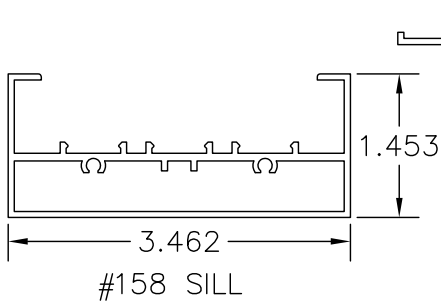

#158 SILL

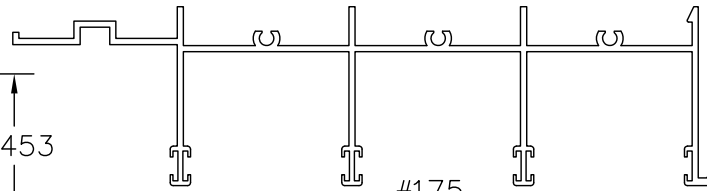

#175
HEAD/JAMB EXTENSION

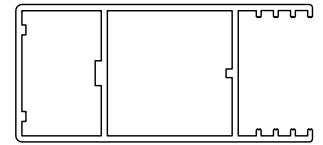

#109
LOCKSTILE

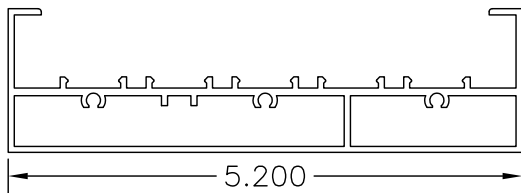

#171 SILL

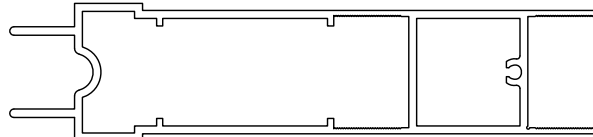

#156
BOTTOM RAIL (MSD4)

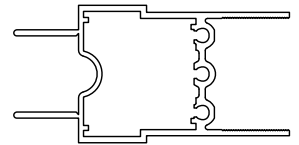

#154
BOTTOM RAIL (MSD)

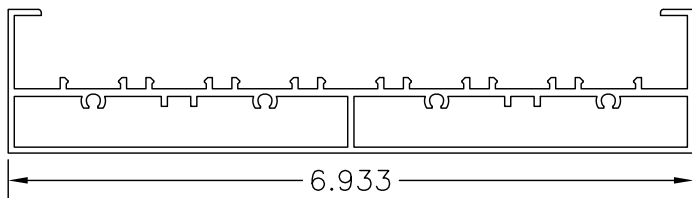

#151 SILL

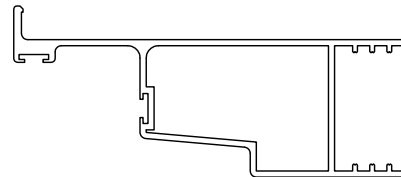

#131
LOCKSTILE BI-DIRECTIONAL

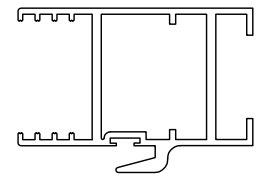

#153
INTERLOCK STILES

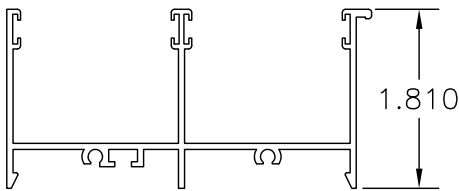

#159 HEAD/JAMB

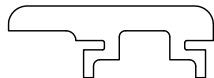

#202
INTERLOCKER
CLIP

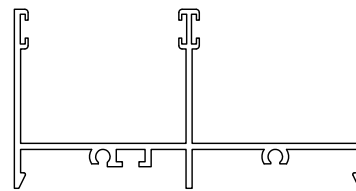

POCKET COVER

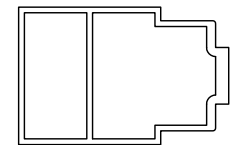

#163
MOUNTING BLOCK
FOR POCKET INTERLOCK

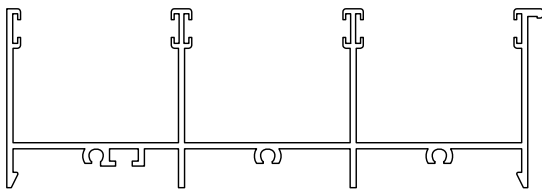

#172 HEAD/JAMB

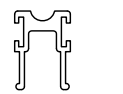

#155
RAIL GUIDE

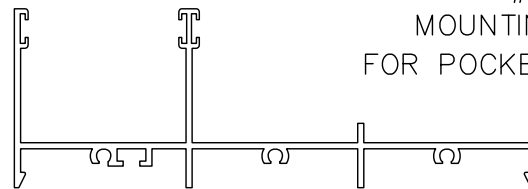

POCKET COVER

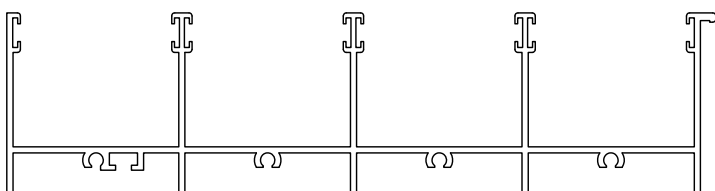

#152 HEAD/JAMB

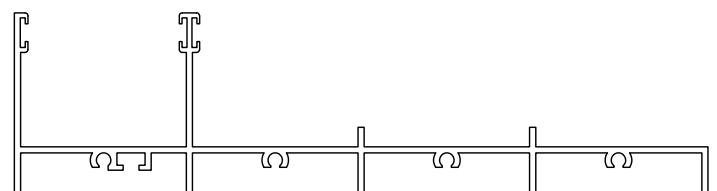

POCKET COVER

MULTI-SLIDING GLASS DOOR EXTRUSIONS

DOUBLE GLAZED

SCALE: 1:2