



WINDOW SYSTEM

SERIES 400 - WINDOW WALL

1503 W. San Pedro St., Gilbert, Arizona 85233
VOICE: 480-892-2600 / FAX : 480-892-0951

A6

DATE:
7/24/13

R:\DRAWINGS\BROGPAGES\A-B\A6.DWG

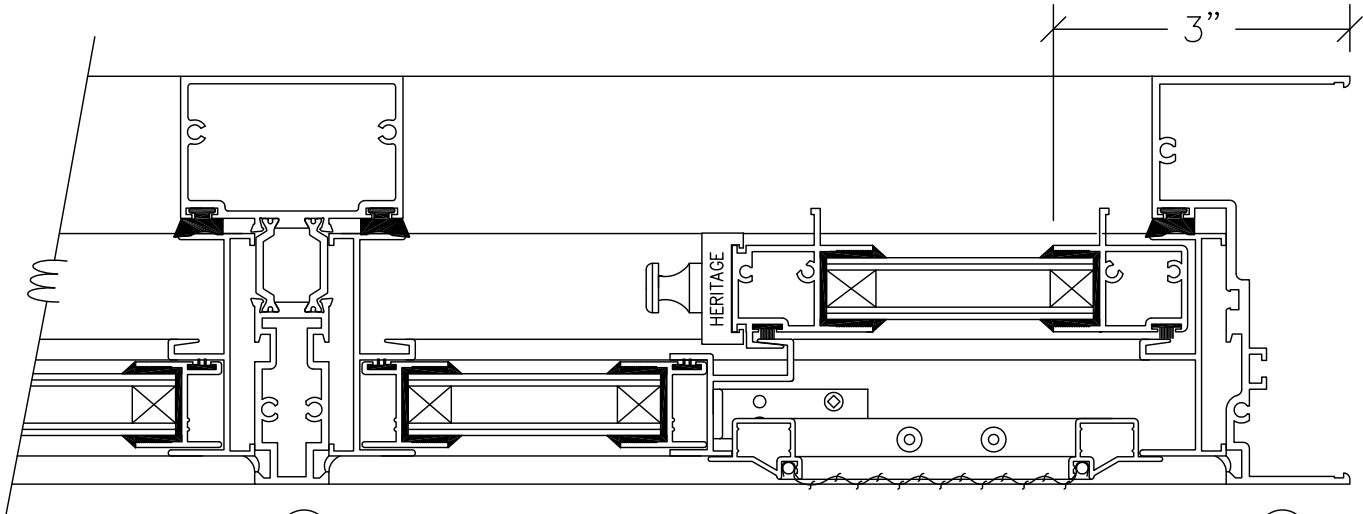
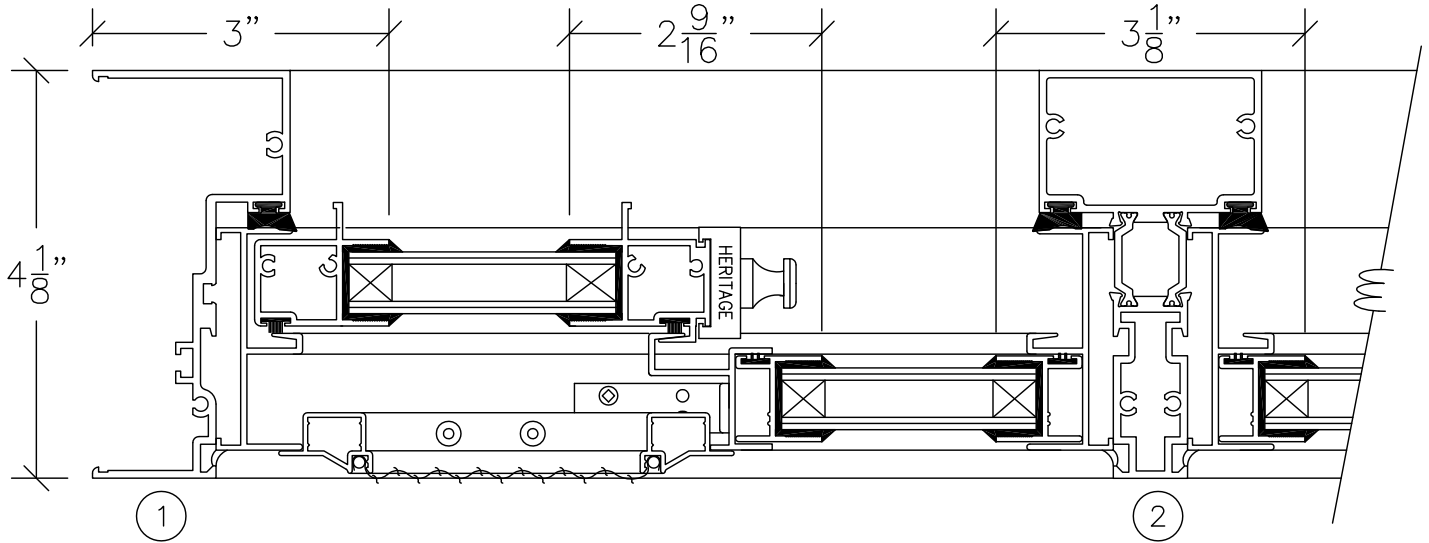

2 VERTICAL MUNTIN

PERIMETER FRAME JAMB 1

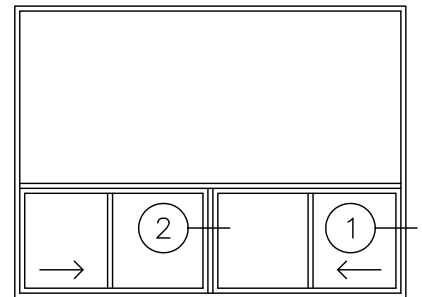
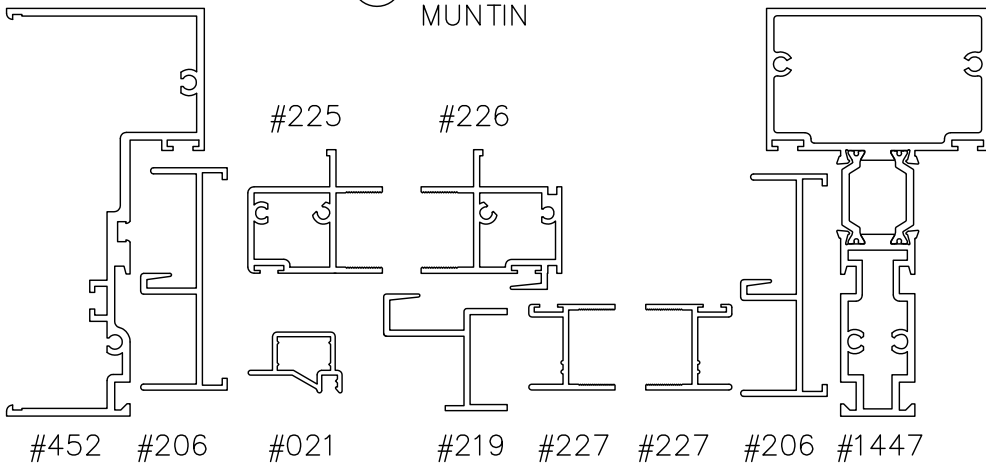

HORIZONTAL SECTION THROUGH 4 1/8" PERIMETER FRAME & STRUCTURAL MUNTIN W/ HORIZONTAL SLIDER INSERT DOUBLE GLAZED
SCALE: HALF SIZE