



# WINDOW SYSTEM

SERIES 400 - WINDOW WALL

1503 W. San Pedro St., Gilbert, Arizona 85233

VOICE: 480-892-2600 / FAX : 480-892-0951

A5

DATE:  
6/1/08

R:\DRAWINGS\BROGPAGES\A-B\A5.DWG

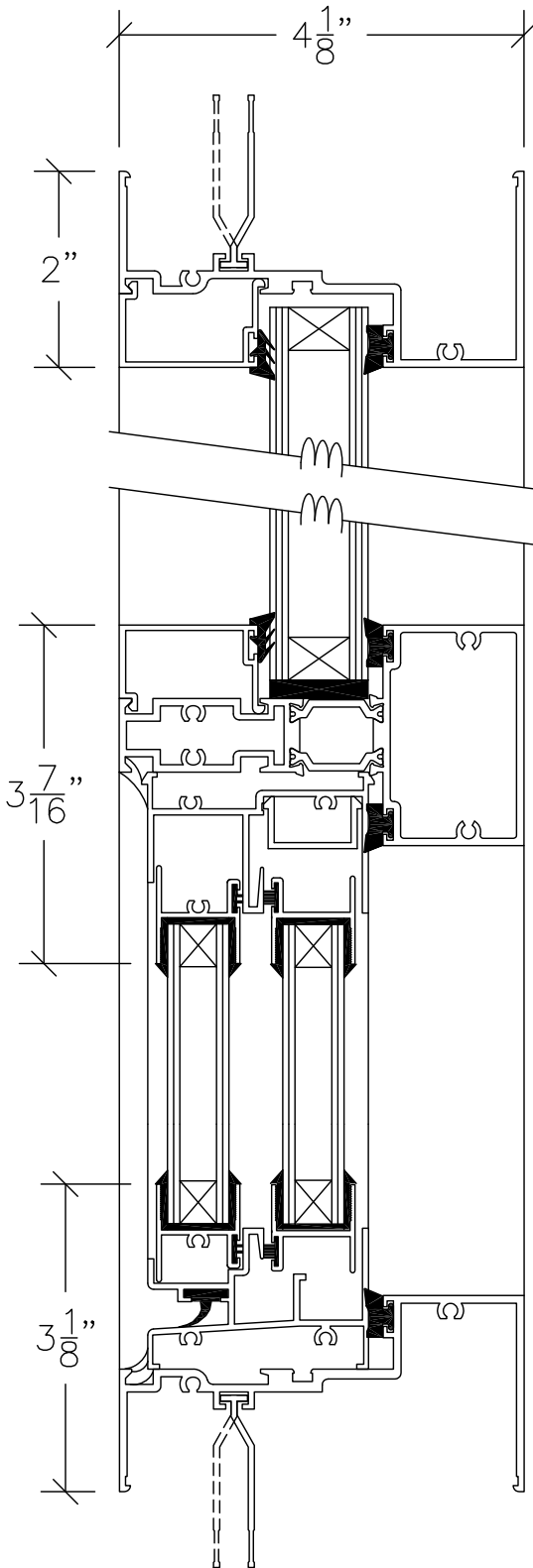

① PERIMETER FRAME  
HEAD/JAMB

② HORIZONTAL MUNTIN

③ PERIMETER FRAME  
SILL

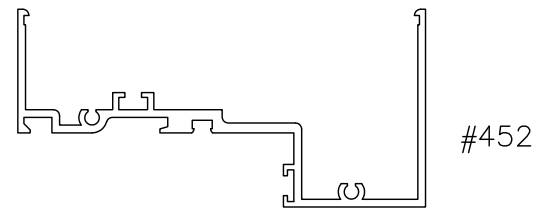

#452



#411

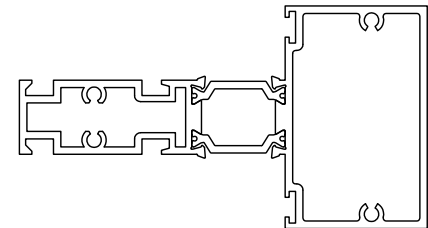

#1447

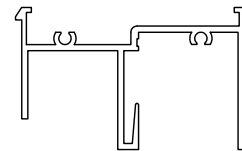

#205

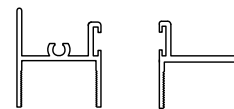

#228/  
#227

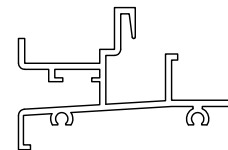

#204

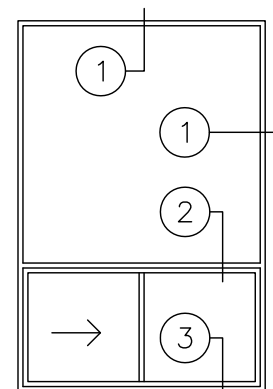

4 1/8" PERIMETER FRAME & MUNTIN DETAIL  
W/ HORIZONTAL SLIDER INSERT - DOUBLE GLAZED

SCALE: HALF SIZE