



WINDOW SYSTEM
SERIES 900 - CASEMENT

1503 W. San Pedro St., Gilbert, Arizona 85233
VOICE: 480-892-2600 / FAX : 480-892-0951

K3

DATE:
6/1/08

R:\DRAWINGS\BROGPAGES\K-1\K3.DWG

① TYPICAL PERIMETER
FRAME & LEAF

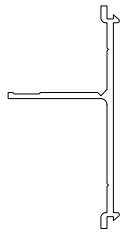
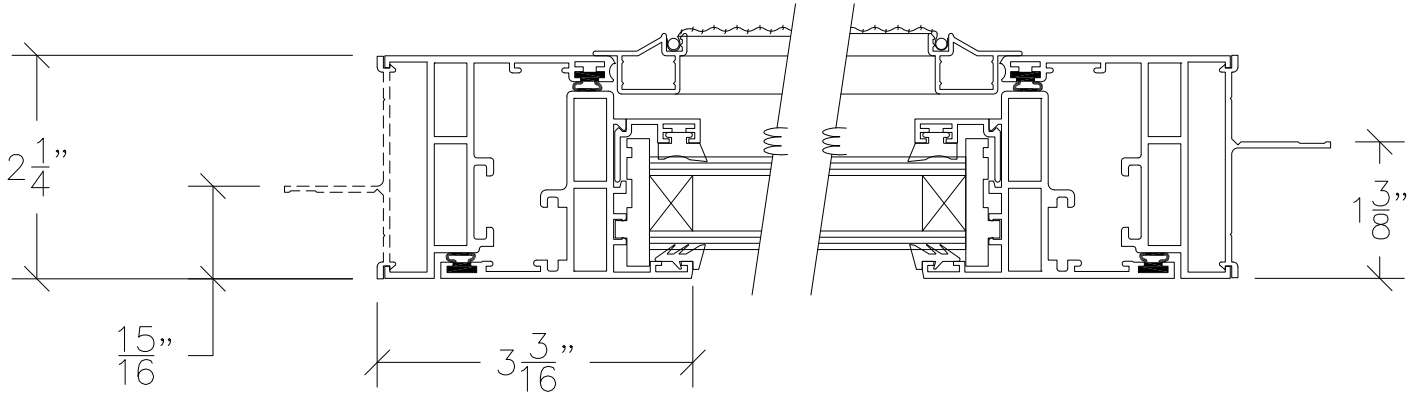

#305

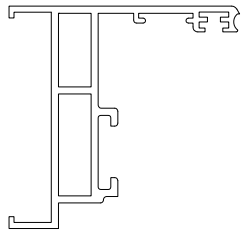

#501

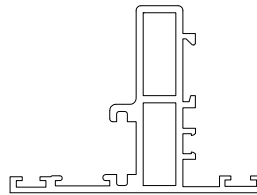

#2502



#441

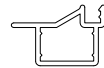

#021

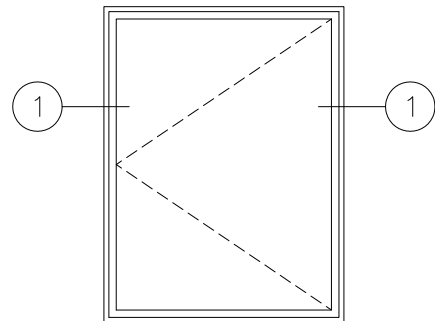

HORIZONTAL SECTION THROUGH CASEMENT WINDOW
DOUBLE GLAZED
SCALE: HALF SIZE