

SMOOTH SLIDING WINDOW SCREEN

HERITAGE sliding window screens also feature an extruded aluminum frame. This design provides a superior seal and added strength to prevent twisting and bending. HERITAGE sliding window screens include proprietary special hardware and assure a proper paint match with the windows.

WEATHER STRIPPING

Made of durable, longer lasting Fin-Seal for proper seal and good looks.

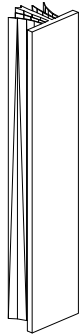

EXTERIOR PULLS BUILT INTO EXTRUSION

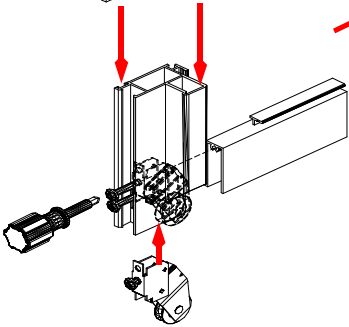

TWO ADJUSTABLE BALL BEARING STEEL ROLLERS

(one in each lower corner) which will allow the screen to glide smoothly when opening and closing the screen.

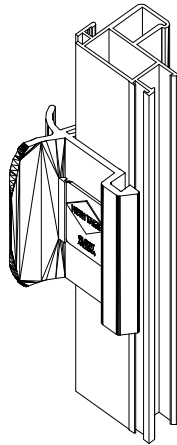

—INTERIOR VIEW—

LOCK-HANDLE MECHANISM

Patented design allows handle to adjust up or down for ease of operation.

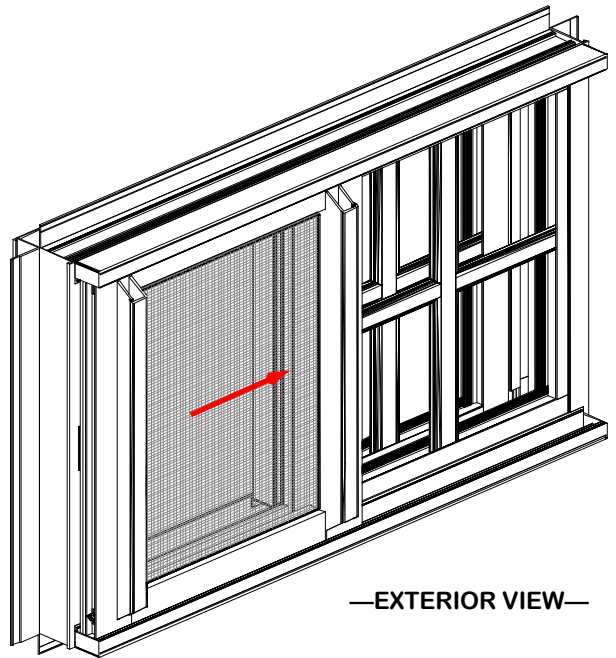

—EXTERIOR VIEW—

TOP/BOTTOM SCREEN TRACK (CROSS SECTION)

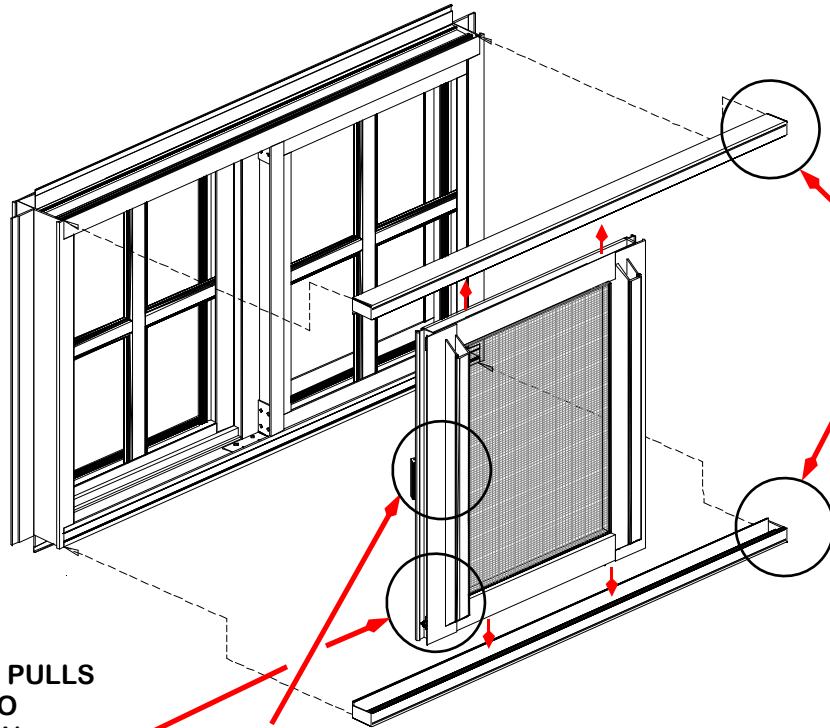
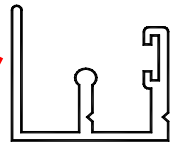

HERITAGE

ALUMINUM WINDOWS AND DOORS

MANUFACTURED BY
TASHCO INDUSTRIES, INC.
1503 W. SAN PEDRO STREET
GILBERT, ARIZONA 85233
PHONE: (480) 892-2600
FAX: (480) 892-0951
MANUFACTURER RESERVES RIGHTS TO
REVISE PRODUCTS WITHOUT PRIOR NOTICE.
PRINTED IN U.S.A. COPYRIGHT 2000.

THE "STANDARD BUG SCREEN" THAT SETS NEW STANDARDS

HERITAGE window screens also feature an extruded aluminum frame with a full flange. This design provides a superior seal and added strength to prevent twisting and bending. HERITAGE window screens include proprietary special hardware and assure a proper paint match with the windows.

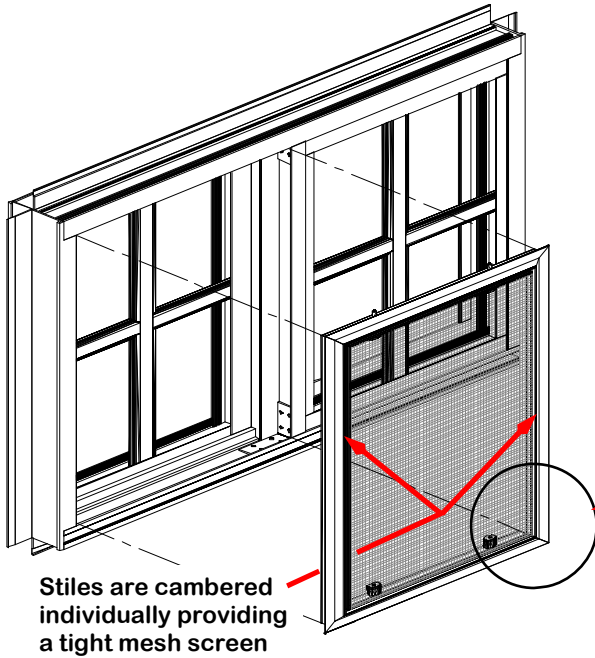

Stiles are cambered individually providing a tight mesh screen

PROPRIETARY LATCHING MECHANISM

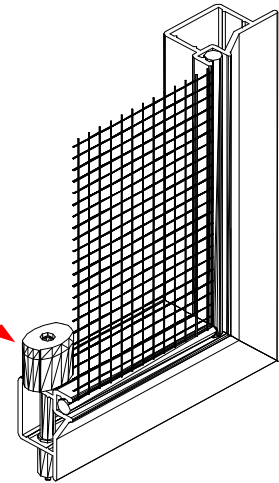
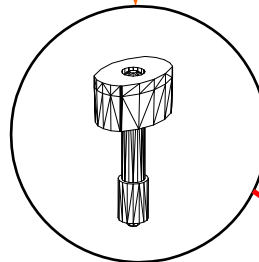

Window screens can be removed and reinstalled by a homeowner from interior and exterior. A simple touch of the latching mechanism from the outside snaps them securely in place on the inside.

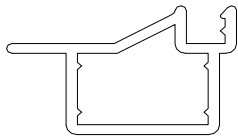

HERITAGE EXTRUDED DESIGN

For added strength



TYPICAL INDUSTRY ROLL FORMED DESIGN

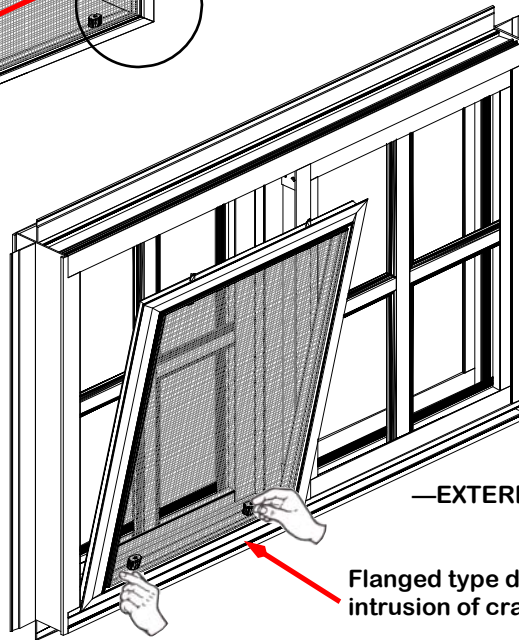

—EXTERIOR VIEW—

Flanged type design reduces intrusion of crawling bugs



ALUMINUM WINDOWS AND DOORS

MANUFACTURED BY
TASHCO INDUSTRIES, INC.
1503 W. SAN PEDRO STREET
GILBERT, ARIZONA 85233
PHONE: (480) 892-2600
FAX: (480) 892-0951
MANUFACTURER RESERVES RIGHTS TO
REVISE PRODUCTS WITHOUT PRIOR NOTICE.
PRINTED IN U.S.A. COPYRIGHT 2000.