



DOOR SYSTEM - RESIDENTIAL
 SERIES 151 - MULTI-SLIDING GLASS DOOR (MSD4 SC)

1503 W. San Pedro St., Gilbert, Arizona 85233
 VOICE: 480-892-2600 / FAX : 480-892-0951

F22D

DATE:
 5/6/11

DRAWINGS\BROPAGES\E-F\F22D.DWG

① MULTI-SLIDING GLASS DOOR
 HEAD + 190 SCREEN TRACK

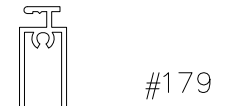
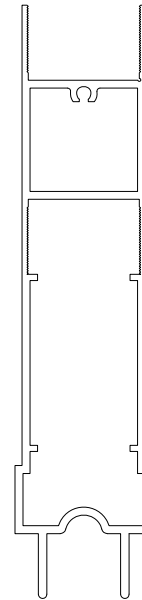
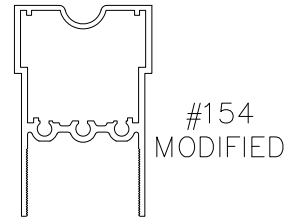
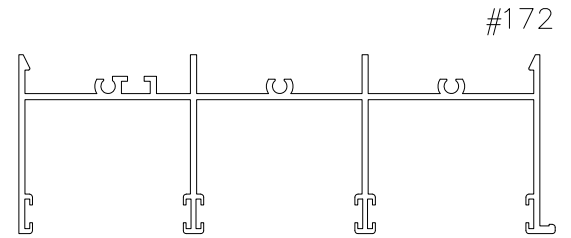
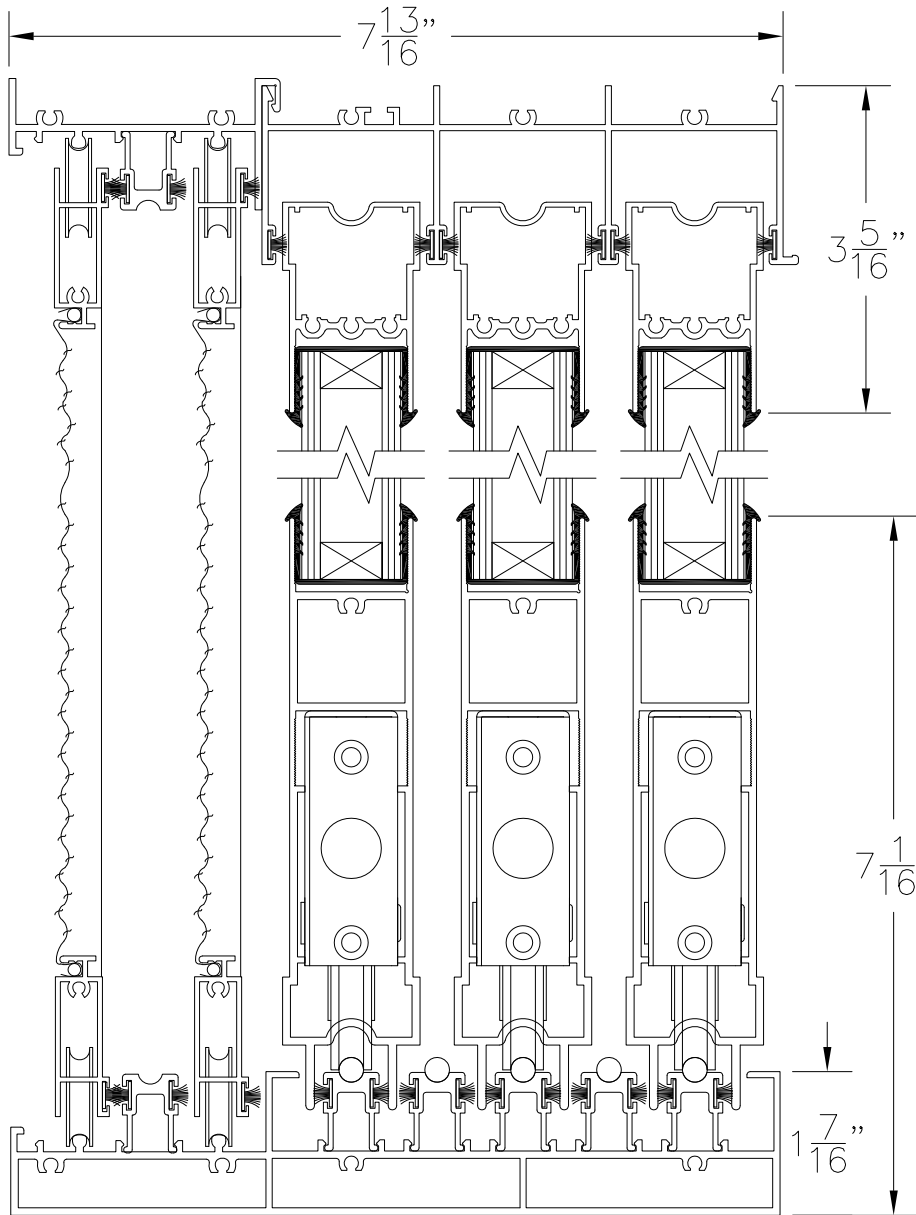
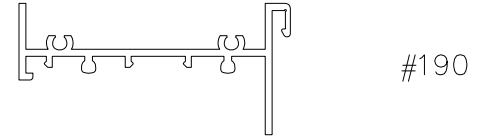

② MULTI-SLIDING GLASS
 DOOR SILL (WITH SCREENS)

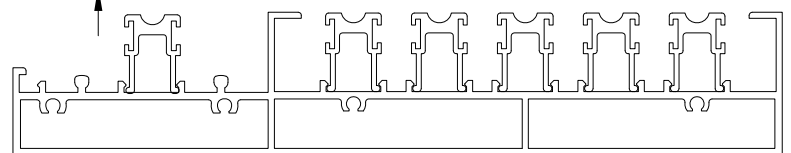

VERTICAL SECTION THROUGH MULTI-SLIDING GLASS DOOR WITH SCREENS
 NO POCKET - DOUBLE GLAZED

SCALE: 1:2