



WINDOW SYSTEM
SERIES 430 - SWINGING DOOR

B6

1503 W. San Pedro St., Gilbert, Arizona 85233
VOICE: 480-892-2600 / FAX : 480-892-0951

DATE:
5/6/11

R:\DRAWINGS\BROPAGES\A-B\B6.DWG

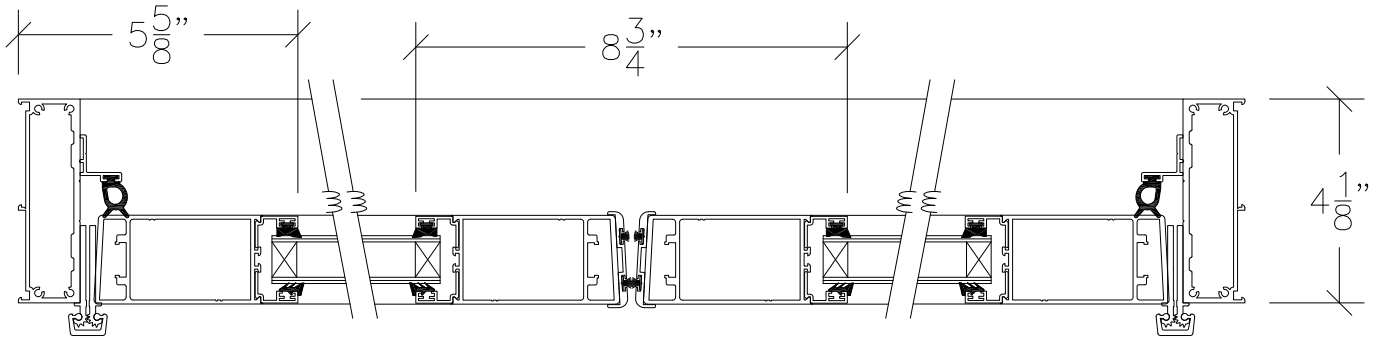

① TYPICAL JAMB & DOOR STILE

② ACTIVE / ACTIVE

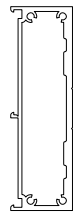

#406

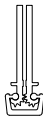

#402

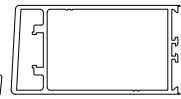

#432



#438



#417



#441

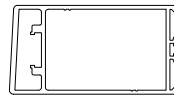

#432



#402

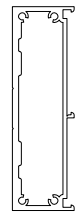

#406

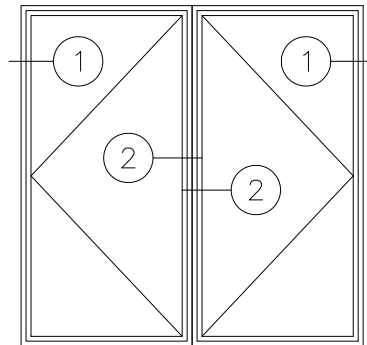

HORIZONTAL SECTION THROUGH HINGE/LOCKSTILE
ACTIVE / ACTIVE FRDR
SCALE: QUARTER SIZE