



WINDOW SYSTEM—INSTALLATION OPTIONS

SERIES 1400 - THERMAL BREAK WINDOW WALL

1503 W. San Pedro St., Gilbert, Arizona 85233
VOICE: 480-892-2600/FAX : 480-892-0951/WWW.HERITAGEWINDOWS.COM

AA9

DATE:
5/6/11

R:\DRAWINGS\BROPAGE\AA\AA9.DWG

OPTION #1

YOU CAN INSTALL IT BY REMOVING THE JAMB STOPS AND RUNNING SCREWS:
SCREWS WILL NOT SHOW

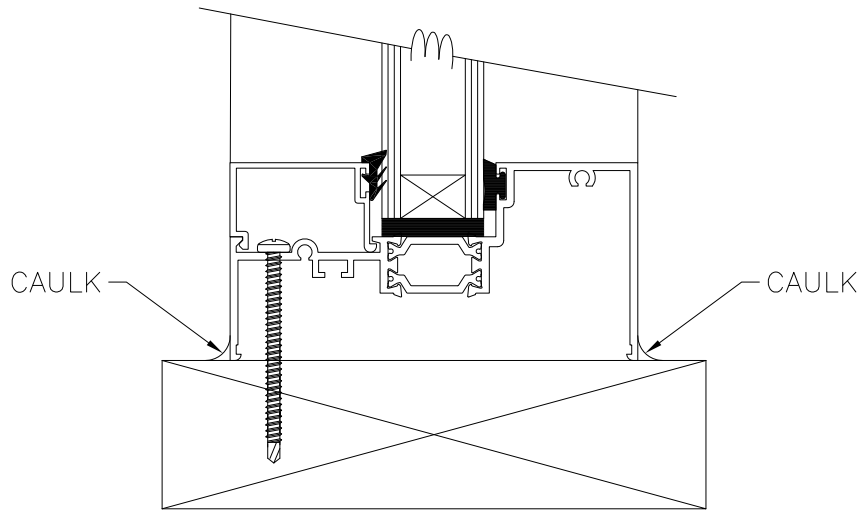

OPTION #2

YOU CAN INSTALL IT BY RUNNING SCREWS
OVER THE STOPS: SCREWS WILL SHOW

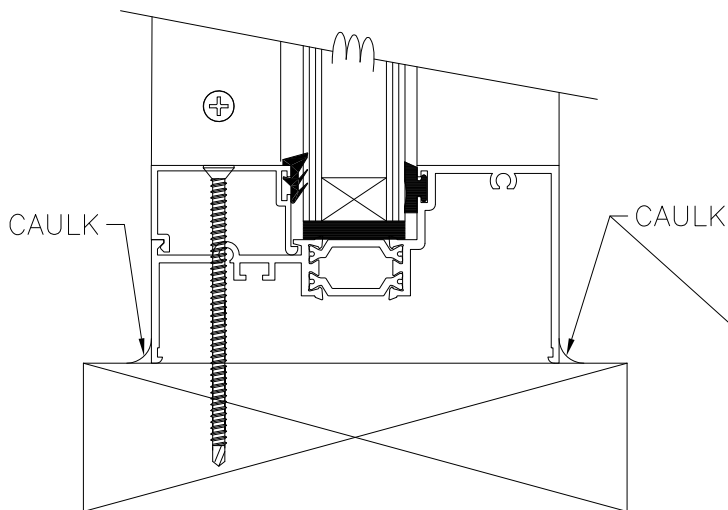

OPTION #3

WE CAN PROVIDE TABS THAT ARE ATTACHED
TO THE JAMBS. YOU DRIVE SCREWS THROUGH
THEM. THEN THE DRYWALL RETURNS WILL
HAVE TO BE NOTCHED.

