



WINDOW SYSTEM—INSTALLATION OPTIONS

SERIES 1400 - THERMAL BREAK WINDOW WALL

1503 W. San Pedro St., Gilbert, Arizona 85233
VOICE: 480-892-2600/FAX : 480-892-0951/WWW.HERITAGEWINDOWS.COM

AA10

DATE:
5/6/11

R:\DRAWINGS\BROPAGES\AA\AA10.DWG

OPTION #4

WHEN THE OPENING IS 2 X 6 FRAMING, BUCK THE OPENING WITH 2 X 4

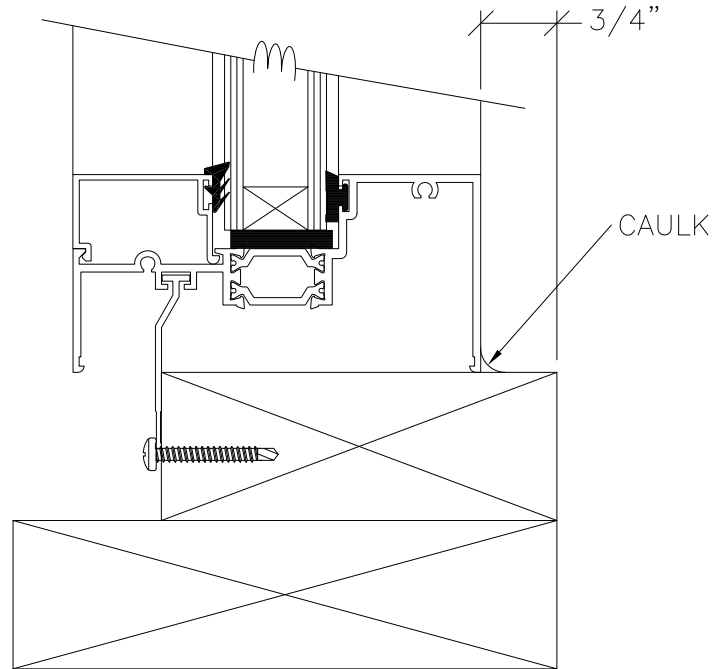

OPTION #5

WHEN THE OPENING IS MASONRY, BUCK THE OPENING WITH 2 X 4

