



WINDOW SYSTEM—INSTALLATION OPTIONS

SERIES 400 - WINDOW WALL

1503 W. San Pedro St., Gilbert, Arizona 85233

VOICE: 480-892-2600 / FAX : 480-892-0951

A11

DATE:
6/1/08

R:\DRAWINGS\BROGPAGES\A-B\A11.DWG

OPTION #1

YOU CAN INSTALL IT BY REMOVING THE JAMB STOPS AND RUNNING SCREWS:
SCREWS WILL NOT SHOW

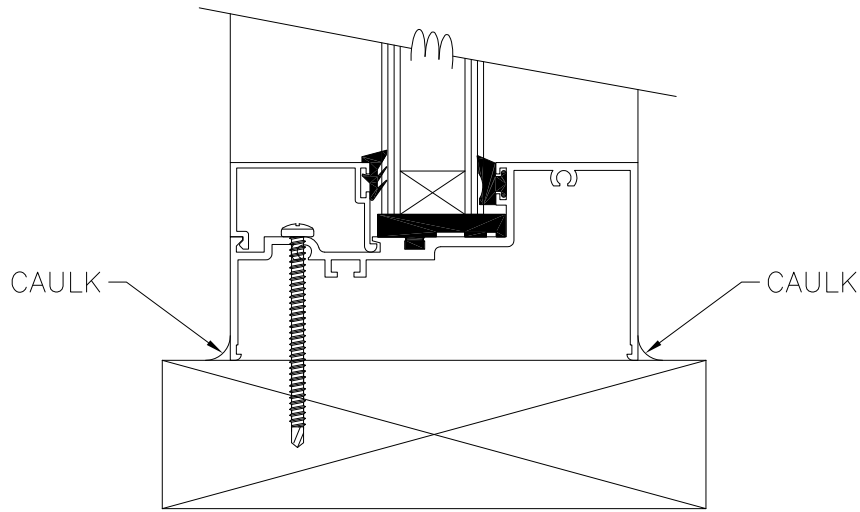

OPTION #2

YOU CAN INSTALL IT BY RUNNING SCREWS
OVER THE STOPS: SCREWS WILL SHOW

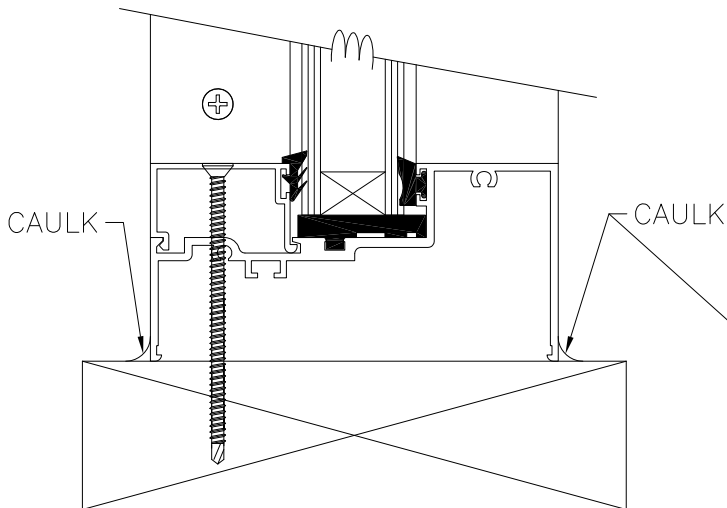

OPTION #3

WE CAN PROVIDE TABS THAT ARE ATTACHED
TO THE JAMBS. YOU DRIVE SCREWS THROUGH
THEM. THEN THE DRYWALL RETURNS WILL
HAVE TO BE NOTCHED.

