



WINDOW SYSTEM

SERIES 1200 - THERMAL BREAK SLIDING WINDOW

1503 W. San Pedro St., Gilbert, Arizona 85233
VOICE: 480-892-2600/FAX : 480-892-0951/WWW.HERITAGEWINDOWS.COM

GG1

DATE:
9/16/11

R:\DRAWINGS\BROPAGES\GG\GG1.DWG

NU-WALL

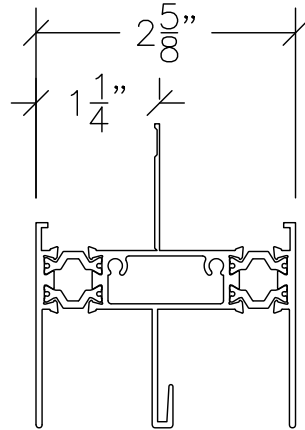

#1251
HEAD

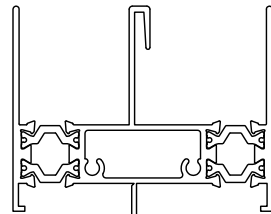

#1251
JAMB

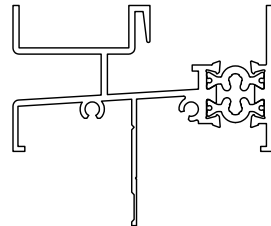

#1250
SILL

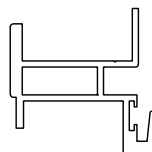

#1207
MEETING RAIL

1 3/8" FIN SET BACK
FOR 1" FOAM &
3/8" STUCCO

MASONRY

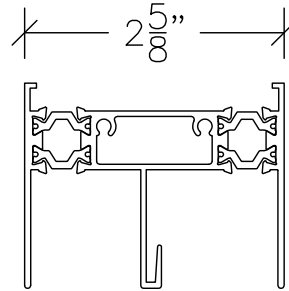

#1251
HEAD

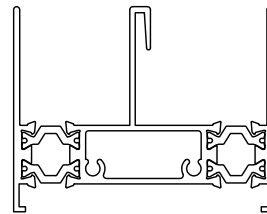

#1251
JAMB

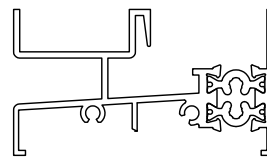

#1250
SILL

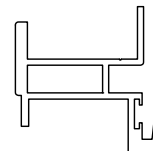

#1207
MEETING RAIL

MASONRY USED
IN BLOCK CONSTRUCTION
AND FOR MULL / STACK
APPLICATIONS

HORIZONTAL SLIDER PERIMETER FRAME EXTRUSIONS

SCALE: HALF SIZE