



WINDOW SYSTEM

SERIES 1200 - THERMAL BREAK SLIDING WINDOW

1503 W. San Pedro St., Gilbert, Arizona 85233
VOICE: 480-892-2600/FAX : 480-892-0951/WWW.HERITAGEWINDOWS.COM

GG5

DATE:
9/16/11

R:\DRAWINGS\BROFAGES\GG\GG5.DWG

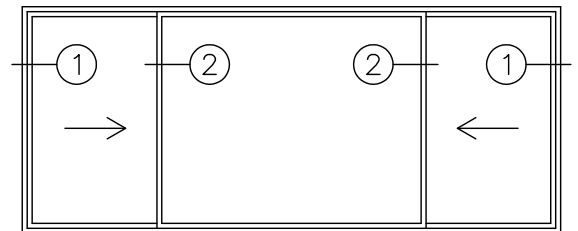
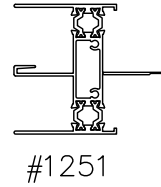
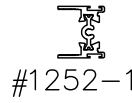
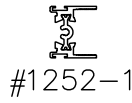
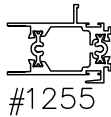
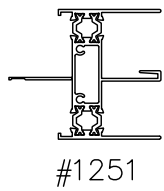
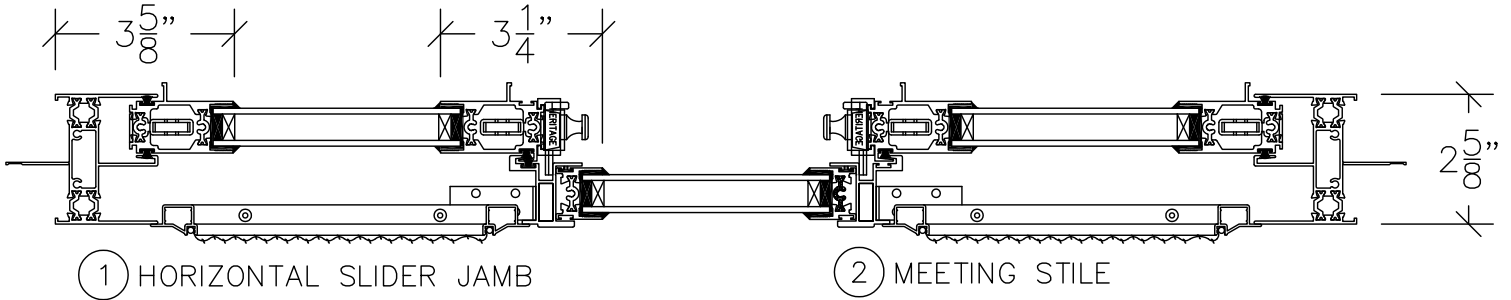

HORIZONTAL SECTION THROUGH HORIZONTAL SLIDER
DOUBLE GLAZED
SCALE: QUARTER SIZE