



# WINDOW SYSTEM

SERIES 1210 - SINGLE HUNG WINDOW

1503 W. San Pedro St., Gilbert, Arizona 85233  
VOICE: 480-892-2600/FAX : 480-892-0951/WWW.HERITAGEWINDOWS.COM

# HH1

DATE:  
9/16/11

R:\DRAWINGS\BROPAGES\HH\HH1.DWG

NU-WALL

MASONRY

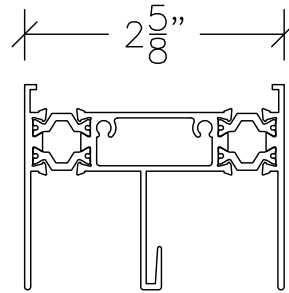
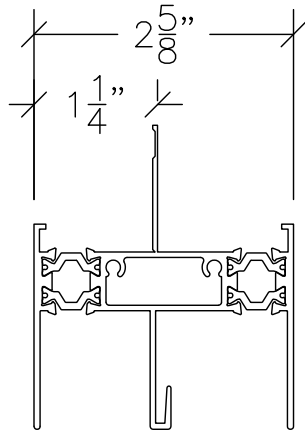

#1251  
HEAD

#1251  
HEAD

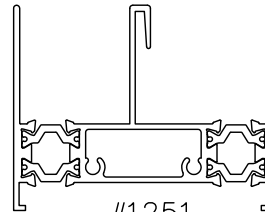
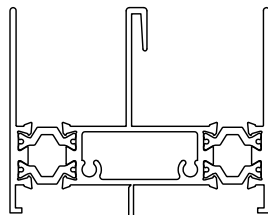

#1251  
JAMB

#1251  
JAMB

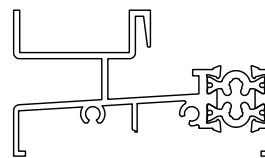
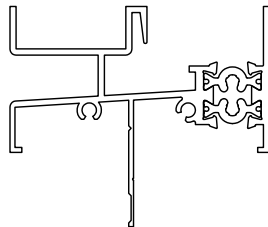

#1250  
SILL

#1250  
SILL

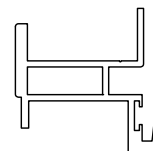
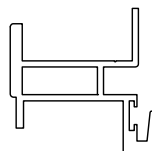

#1207  
MEETING RAIL

#1207  
MEETING RAIL

1 3/8" FIN SET BACK  
FOR 1" FOAM &  
3/8" STUCCO

MASONRY USED  
IN BLOCK CONSTRUCTION  
AND FOR MULL / STACK  
APPLICATIONS

## SINGLE HUNG PERIMETER FRAME EXTRUSIONS

SCALE: HALF SIZE