



WINDOW SYSTEM

SERIES 1250 - THERMAL BREAK FIXED WINDOW

1503 W. San Pedro St., Gilbert, Arizona 85233
VOICE: 480-892-2600/FAX : 480-892-0951/WWW.HERITAGEWINDOWS.COM

III1

DATE:
5/6/11

R:\DRAWINGS\BROGPAGES\III1.DWG

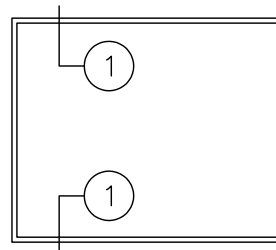
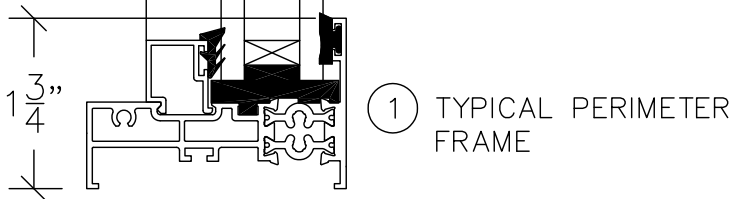
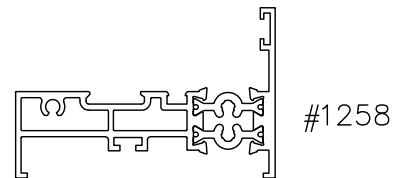
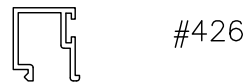
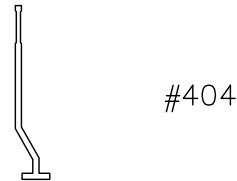
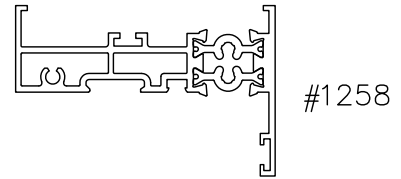
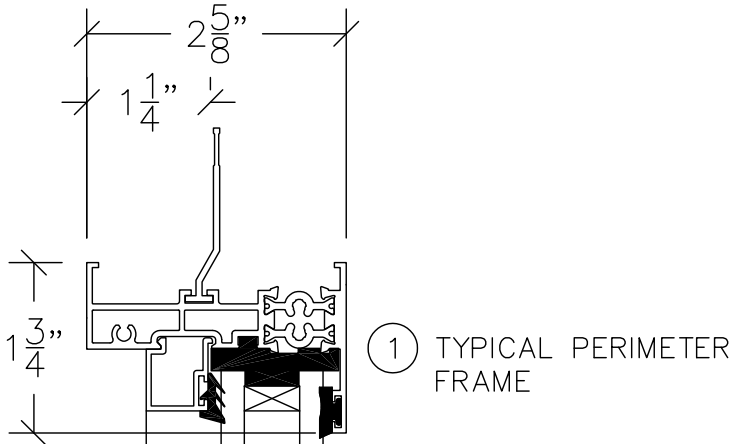

VERTICAL SECTION THROUGH THERMAL BREAK FIXED WINDOW
DOUBLE GLAZED
SCALE: HALF SIZE