



WINDOW SYSTEM

SERIES 1250 - THERMAL BREAK FIXED WINDOW

1503 W. San Pedro St., Gilbert, Arizona 85233
VOICE: 480-892-2600/FAX : 480-892-0951/WWW.HERITAGEWINDOWS.COM

III1

DATE:
5/6/11

R:\DRAWINGS\BROGPAGES\III1.DWG

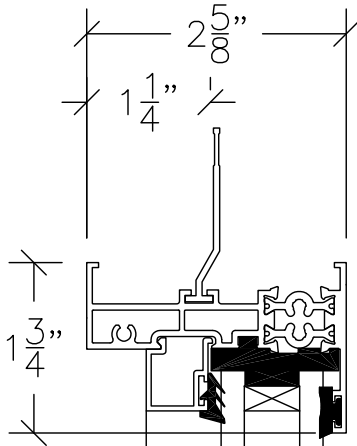

① TYPICAL PERIMETER FRAME

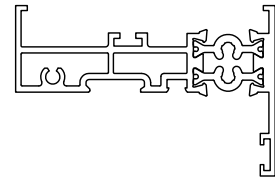

#1258



#404



#426

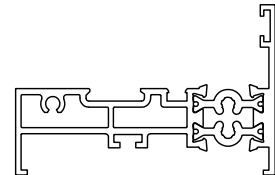

#1258

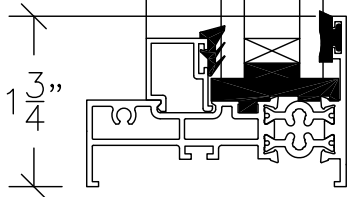

① TYPICAL PERIMETER FRAME

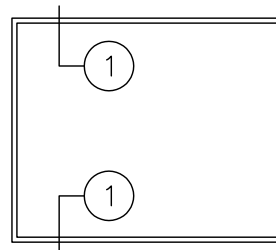

VERTICAL SECTION THROUGH THERMAL BREAK FIXED WINDOW
DOUBLE GLAZED

SCALE: HALF SIZE



WINDOW SYSTEM

SERIES 1250 - THERMAL BREAK FIXED WINDOW

1503 W. San Pedro St., Gilbert, Arizona 85233
VOICE: 480-892-2600/FAX : 480-892-0951/WWW.HERITAGEWINDOWS.COM

II2

DATE:
5/6/11

R:\DRAWINGS\BROGPAGES\II\II2.DWG

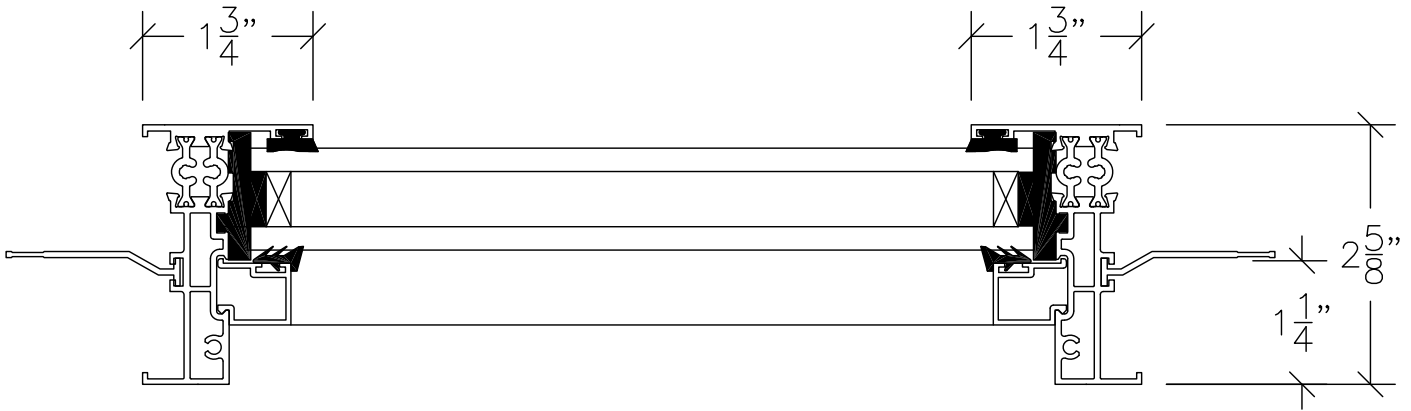

① TYPICAL PERIMETER FRAME

① TYPICAL PERIMETER FRAME

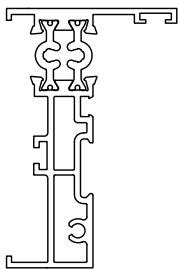

#1258

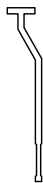

#404



#426

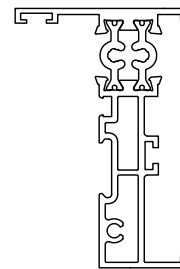

#1258

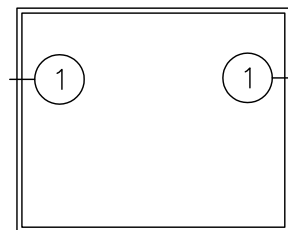

HORIZONTAL SECTION THROUGH THERMAL BREAK FIXED WINDOW
DOUBLE GLAZED

SCALE: HALF SIZE



WINDOW SYSTEM

SERIES 1250 - THERMAL BREAK FIXED WINDOW

1503 W. San Pedro St., Gilbert, Arizona 85233
VOICE: 480-892-2600/FAX : 480-892-0951/WWW.HERITAGEWINDOWS.COM

II3

DATE:
7/30/13

R:\DRAWINGS\BROPAGE\II3.DWG

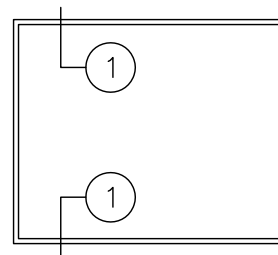
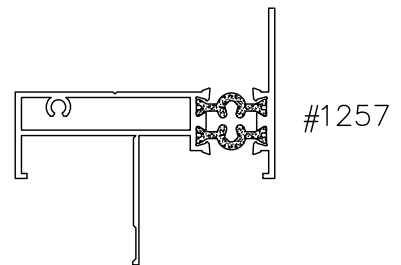
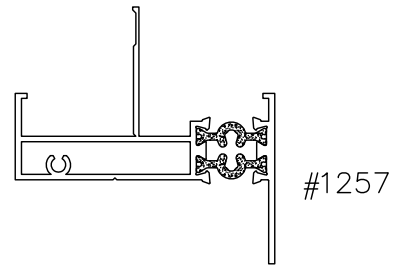
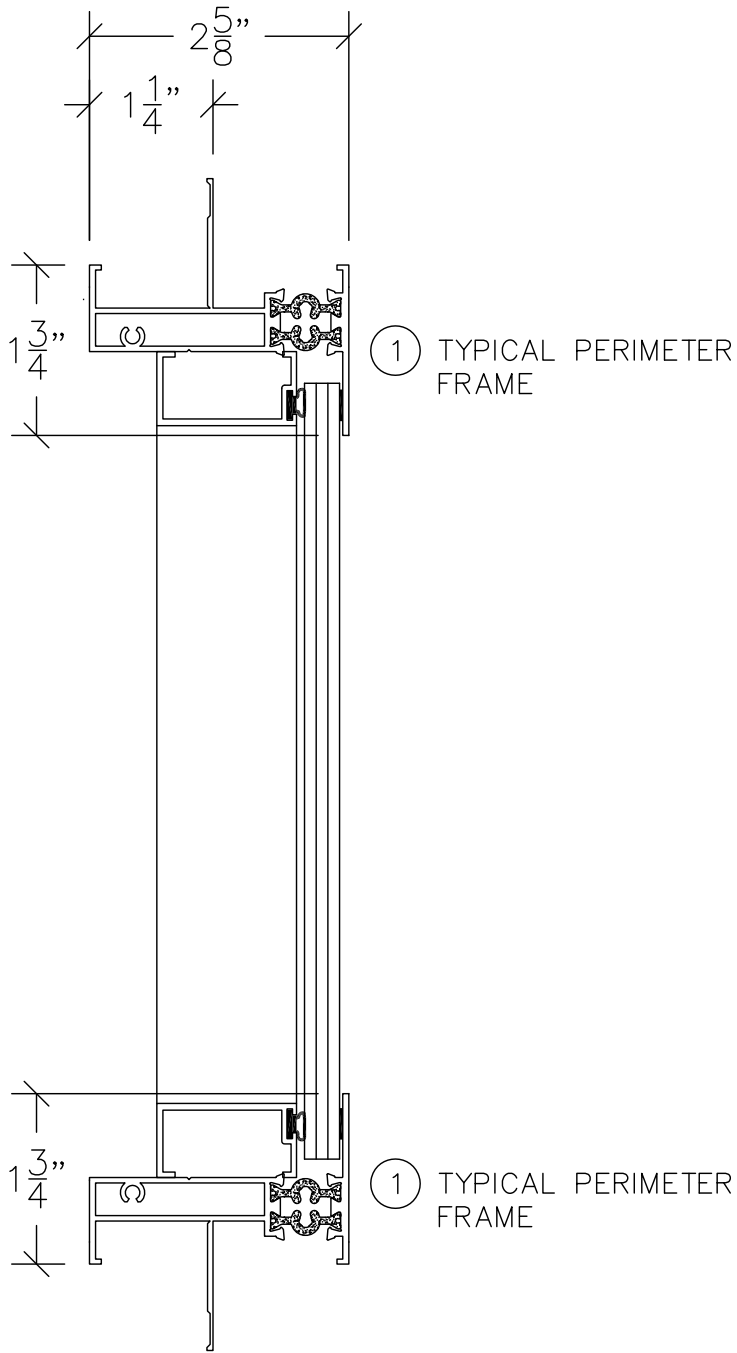

VERTICAL SECTION THROUGH THERMAL BREAK FIXED WINDOW
SINGLE GLAZED
SCALE: HALF SIZE



WINDOW SYSTEM

SERIES 1250 - THERMAL BREAK FIXED WINDOW

1503 W. San Pedro St., Gilbert, Arizona 85233
VOICE: 480-892-2600/FAX : 480-892-0951/WWW.HERITAGEWINDOWS.COM

II4

DATE:
7/30/13

R:\DRAWINGS\BOPAGES\II4.DWG

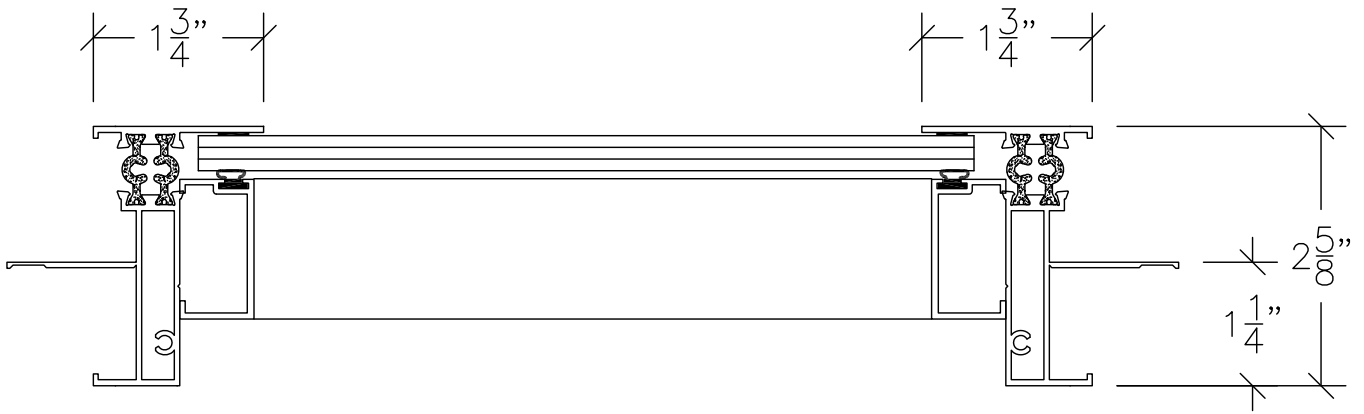

① TYPICAL PERIMETER FRAME

① TYPICAL PERIMETER FRAME

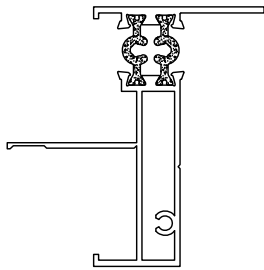

#1257



#413 STOP

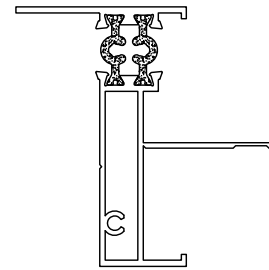

#1257

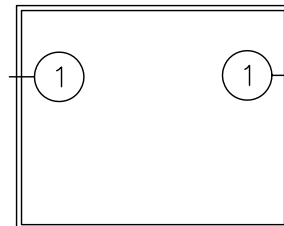

HORIZONTAL SECTION THROUGH THERMAL BREAK FIXED WINDOW
SINGLE GLAZED

SCALE: HALF SIZE



WINDOW SYSTEM

SERIES 1250 - THERMAL BREAK FIXED WINDOW

1503 W. San Pedro St., Gilbert, Arizona 85233
VOICE: 480-892-2600/FAX : 480-892-0951/WWW.HERITAGEWINDOWS.COM

115

DATE:
5/6/11

R:\DRAWINGS\BROPAGE\11\115.DWG

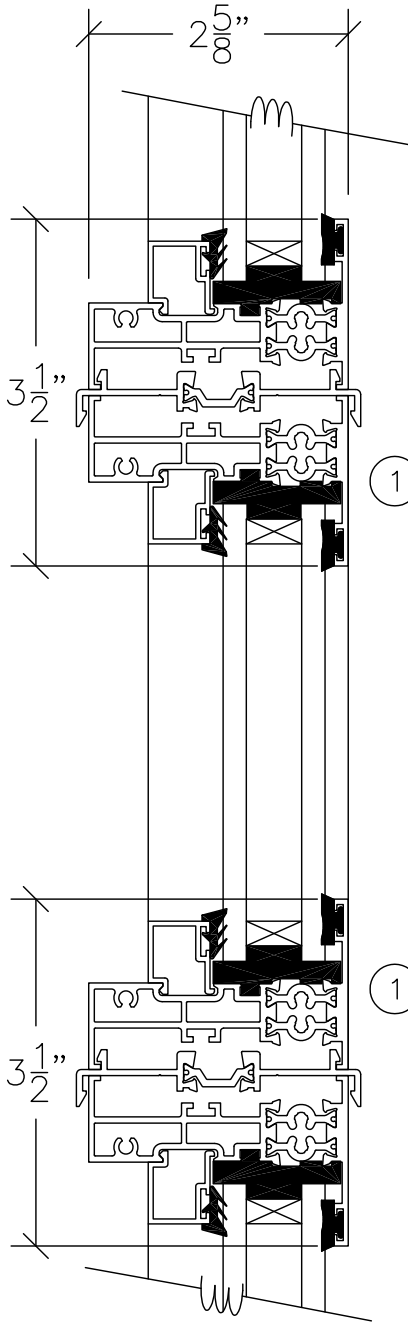

① FIXED FRAME PERIMETERS
© STACK

① FIXED FRAME PERIMETERS
© STACK

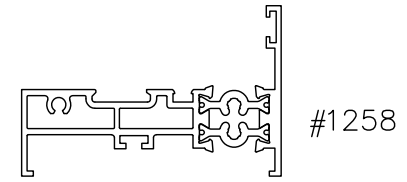

#1258

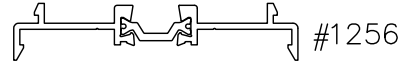

#1256

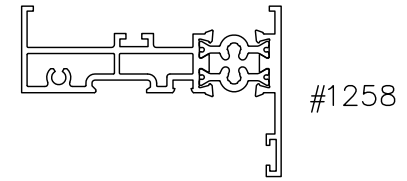

#1258

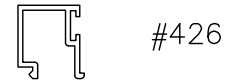

#426

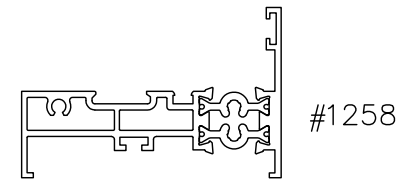

#1258

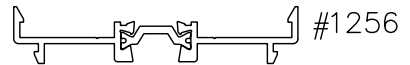

#1256

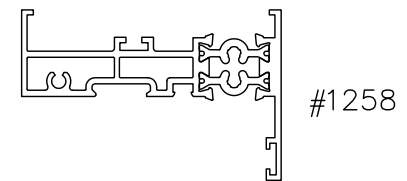

#1258

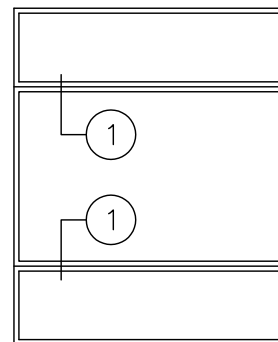

VERTICAL SECTION THROUGH THERMAL BREAK FIXED FRAME
© STACK DOUBLE GLAZED

SCALE: HALF SIZE



WINDOW SYSTEM

SERIES 1250 - THERMAL BREAK FIXED WINDOW

1503 W. San Pedro St., Gilbert, Arizona 85233
VOICE: 480-892-2600/FAX : 480-892-0951/WWW.HERITAGEWINDOWS.COM

116

DATE:
5/6/11

R:\DRAWINGS\BROGPAGES\11\116.DWG

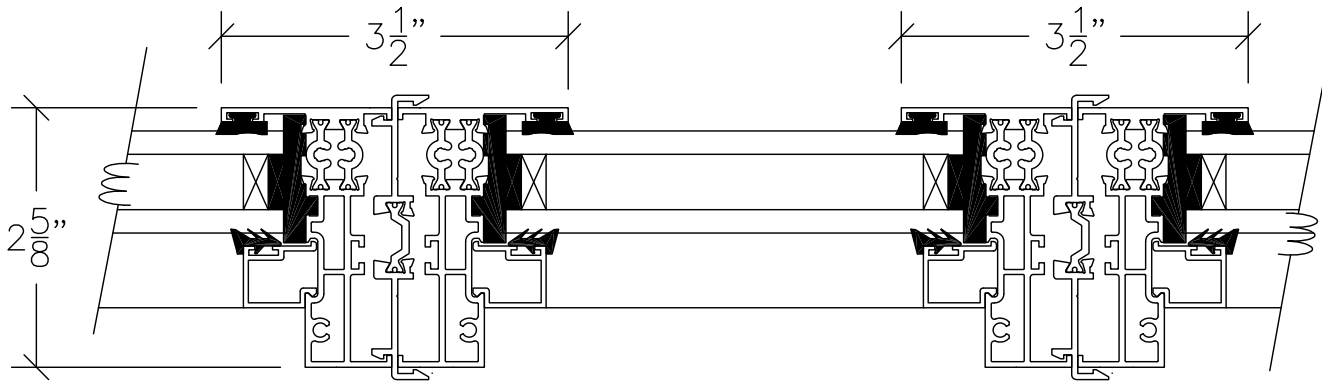

1

FIXED FRAME PERIMETERS
@ MULL

1

FIXED FRAME PERIMETERS
@ MULL

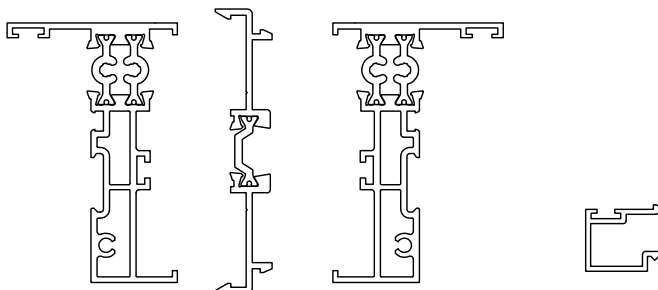

#1258

#1256

#1258

#426

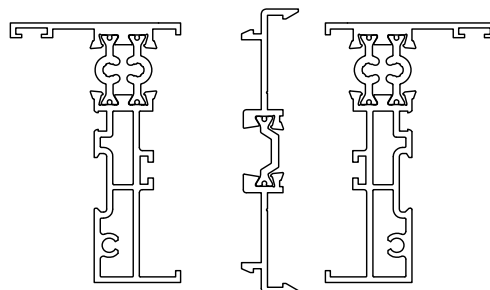

#1258

#1256

#1258

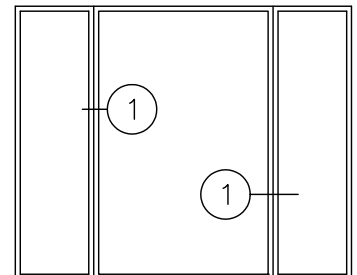

HORIZONTAL SECTION THROUGH THERMAL BREAK FIXED FRAME
@ MULL DOUBLE GLAZED

SCALE: HALF SIZE