



# WINDOW SYSTEM

SERIES 1250 - THERMAL BREAK FIXED WINDOW

1503 W. San Pedro St., Gilbert, Arizona 85233  
VOICE: 480-892-2600/FAX : 480-892-0951/WWW.HERITAGEWINDOWS.COM

115

DATE:  
5/6/11

R:\DRAWINGS\BROPAGE\11\115.DWG

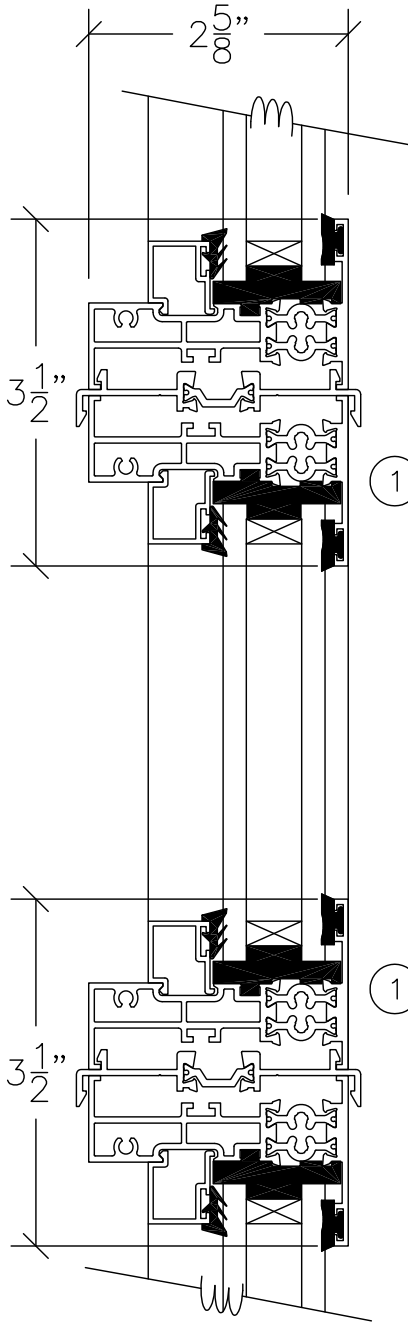

① FIXED FRAME PERIMETERS  
© STACK

① FIXED FRAME PERIMETERS  
© STACK

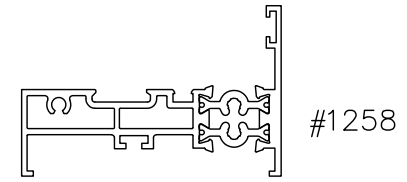

#1258

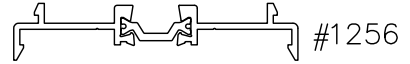

#1256

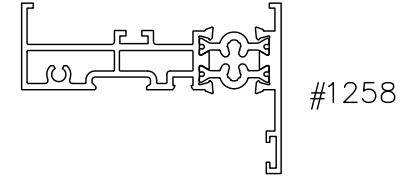

#1258



#426

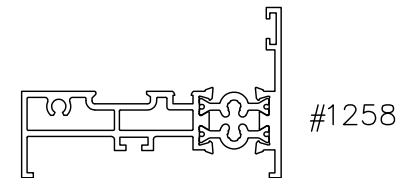

#1258

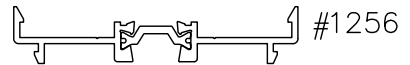

#1256

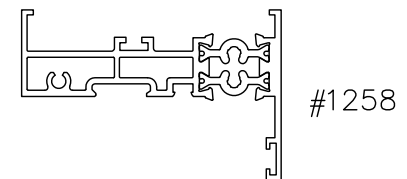

#1258

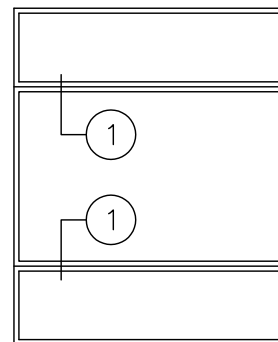

VERTICAL SECTION THROUGH THERMAL BREAK FIXED FRAME  
© STACK DOUBLE GLAZED

SCALE: HALF SIZE