



# DOOR SYSTEM – RESIDENTIAL

SERIES 1100 – THERMAL BREAK SLIDING GLASS DOOR

1503 W. San Pedro St., Gilbert, Arizona 85233  
VOICE: 480-892-2600/FAX : 480-892-0951/WWW.HERITAGEWINDOWS.COM

DD7

DATE:  
12/4/13

R:\DRAWINGS\BROGPAGES\DD\_DD7.DWG

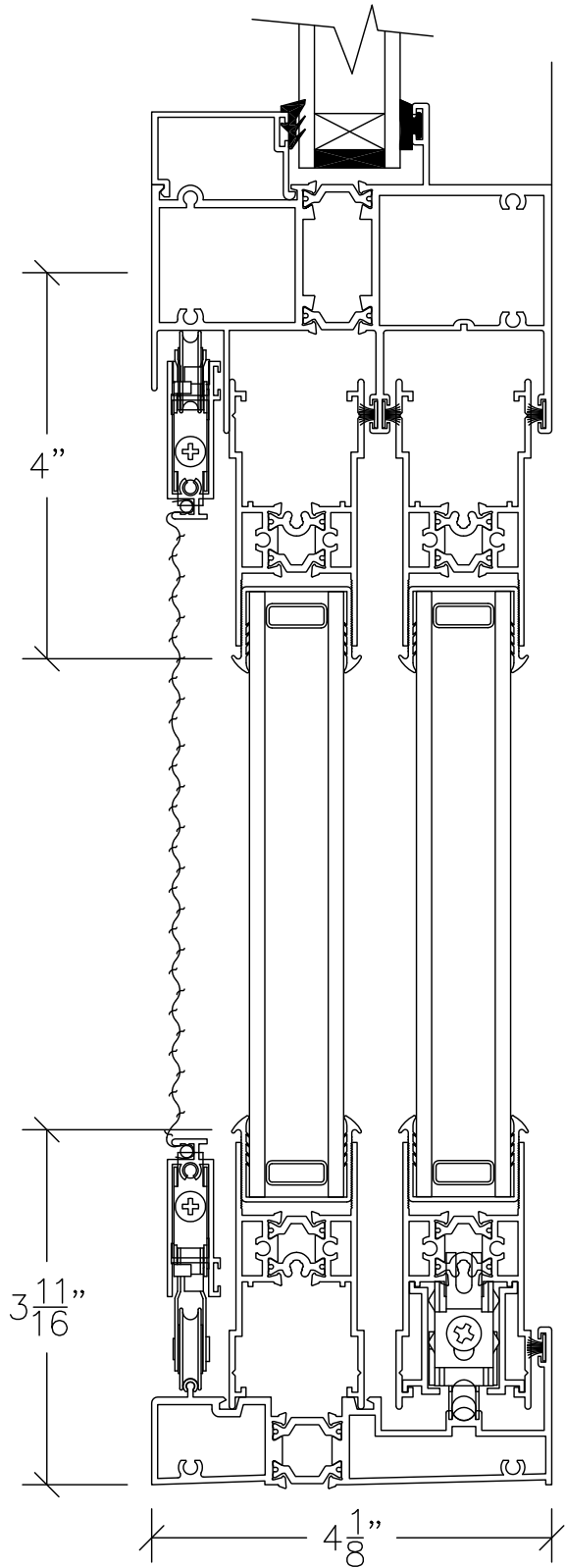

① SLIDING GLASS DOOR HEAD

② SLIDING GLASS DOOR SILL

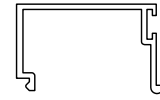

#411

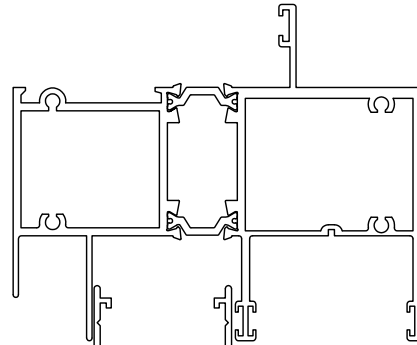

#1439

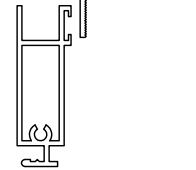

#179

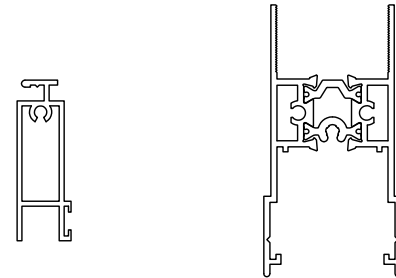

#1154

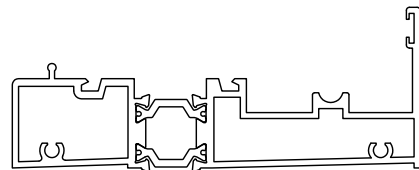

#1151

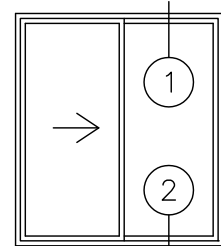

VERTICAL SECTION THROUGH THERMAL BREAK SLIDING GLASS DOOR W/TRANSOM DOUBLE GLAZED

SCALE: 1:2